

BK 37, BK 28, BK 29

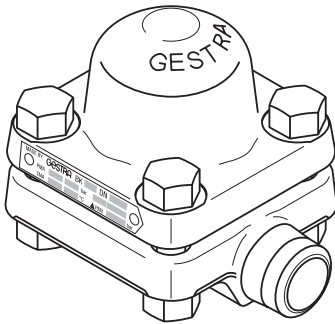

BK 37-ASME, BK 28-ASME, BK 29-ASME

Steam Traps

BK 37 / BK 37-ASME, PN 63/CL 400, DN 15, 20, 25

BK 28 / BK 28-ASME, PN 100/CL 600, DN 15, 20, 25

BK 29 / BK 29-ASME, PN 160/CL 900, DN 15, 20, 25

Description

Thermostatic/thermodynamic steam trap with corrosion resistant Thermovit® regulator (bimetallic plates) able to withstand waterhammer. With internal strainer and integral non-return valve action. Asbestos-free body gasket (graphite/CrNi). Installation in any position.

The default factory setting enables the steam trap to discharge condensate with virtually no banking-up.

Function

During start-up of the plant the steam trap is completely open. Cold condensate and air are discharged.

As the temperature rises, the bimetallic plates deflect, drawing the stage nozzle towards the closed position.

Just before the condensate reaches saturated steam temperature the orifice will be shut off tight. The thermodynamic effect of the stage nozzle chamber assists in the closing process.

The steam trap provides automatic air-venting at start-up and during operation of the plant. BK 37..., BK 28... and BK 29... can also be used for thermal air-venting.

Temperature/Pressure Ratings & End Connections

BK 37, Flanges PN 63 / 100 EN 1092-1

PMA (admissible service pressure)	[bar]g	100	100	94	80.9	73	44.2
TMA (admissible service temperature)	[°C]	20	150	265	350	415	500
Δ PMX (admissible differential pressure)	[barg]	45					

Based on EN 1092-1

BK 37, Butt-weld ends to DIN EN 12627, Socket-weld ends to DIN EN 12760

PMA (admissible service pressure)	[bar]g	100	100	100	85	61	30.9
TMA (admissible service temperature)	[°C]	20	400	450	470	500	530
Δ PMX (admissible differential pressure)	[barg]	45					

Calculated in accordance with DIN EN 12516-2

BK 28, Flanges PN 100 EN 1092-1

PMA (admissible service pressure)	[bar]g	100	100	94	80.9	73	44.2
TMA (admissible service temperature)	[°C]	20	150	265	350	415	500
Δ PMX (admissible differential pressure)	[barg]	85					

Based on EN 1092-1

BK 28, Butt-weld ends to DIN EN 12627, Socket-weld ends to DIN EN 12760

PMA (admissible service pressure)	[bar]g	100	100	100	85	61	30.9
TMA (admissible service temperature)	[°C]	20	400	450	470	500	530
Δ PMX (admissible differential pressure)	[barg]	85					

Calculated in accordance with DIN EN 12516-2

BK 29, Flanges PN 160 EN 1092-1

PMA (admissible service pressure)	[bar]g	160	144	134.8	112	104.3	59.4
TMA (admissible service temperature)	[°C]	20	400	450	485	500	530
Δ PMX (admissible differential pressure)	[barg]	110					

Based on EN 1092-1

BK 29, Butt-weld ends to DIN EN 12627, Socket-weld ends to DIN EN 12760

PMA (admissible service pressure)	[bar]g	160	138	110	100	57	44.5
TMA (admissible service temperature)	[°C]	20	400	491	500	530	540
Δ PMX (admissible differential pressure)	[barg]	110					

Calculated in accordance with DIN EN 12516-2

Temperature/Pressure Ratings & End Connections – continued –

BK 37-ASME, Flanges B16.5 Class 400/600, Butt-weld ends to B16.25 Sched. 80, Socket-weld ends to B16.11 Class 3000							
PMA (admissible service pressure)	[barg]	103.4	100.9	85.7	73.3	67.7	42.8
TMA (admissible service temperature)	[°C]	20	100	300	400	450	500
PMA (admissible service pressure)	[psi]	1500	1400	1210	1065	975	745
TMA (admissible service temperature)	[°F]	100	300	600	750	850	900
Δ PMX (admissible differential pressure)	[barg]	45					
	[psi]	652					

Calculated in accordance with ASME B16.34

BK 28-ASME, Flanges B16.5 Class 600, Butt-weld ends to B16.25 Sched. 80, Socket-weld ends to B16.11 Class 3000							
PMA (admissible service pressure)	[barg]	103.4	100.9	85.7	73.3	67.7	42.8
TMA (admissible service temperature)	[°C]	20	100	300	400	450	500
PMA (admissible service pressure)	[psi]	1500	1400	1210	1065	975	745
TMA (admissible service temperature)	[°F]	100	300	600	750	850	900
Δ PMX (admissible differential pressure)	[barg]	85					
	[psi]	1232					

Calculated in accordance with ASME B16.34

BK 29-ASME, Flanges B16.5 Class 900/1500, Butt-weld ends to B16.25 Sched. 160, Socket-weld ends to B16.11 Class 6000							
PMA (admissible service pressure)	[barg]	155.1	128.6	101.4	64.1	45.9	40.2
TMA (admissible service temperature)	[°C]	20	300	450	500	530	540
PMA (admissible service pressure)	[psi]	2250	1815	1460	1120	825	595
TMA (admissible service temperature)	[°F]	100	600	850	900	950	1000
Δ PMX (admissible differential pressure)	[barg]	110					
	[psi]	1595					

Calculated in accordance with ASME B16.34

Materials

Type	BK 37	BK 37-ASME
Designation	DIN / EN	ASTM
Body and cover	1.5415	A182 F12
Stud bolt with reduced shank	1.7709	A193 B7
Hexagon nut	1.7709	A194 Gr.4
Gasket	Graphite/CrNi	
Temperature sensor	Corrosion resistant Duo S. S.	
Nozzle stem and seat	Wear-resistant titanium alloy	
Other internals	Stainless steels	

Type	BK 28	BK 28-ASME
Designation	DIN / EN	ASTM
Body and cover	1.5415	A182 F12
Stud bolt with reduced shank	1.7709	A193 B7
Hexagon nut	1.7709	A194 Gr.4
Gasket	Graphite/CrNi	
Temperature sensor	Corrosion resistant Duo S. S.	
Nozzle stem and seat	Wear-resistant titanium alloy	
Other internals	Stainless steels	

Type	BK 29	BK 29-ASME
Designation	DIN / EN	ASTM
Body and cover	1.7335	A182 F12
Stud bolt with reduced shank	1.7709	A193 B7
Hexagon nut	1.7709	A194 Gr.4
Gasket	Graphite/CrNi	
Temperature sensor	Corrosion resistant Duo S. S.	
Nozzle stem and seat	Wear-resistant titanium alloy	
Other internals	Stainless steels	

Design BK 37

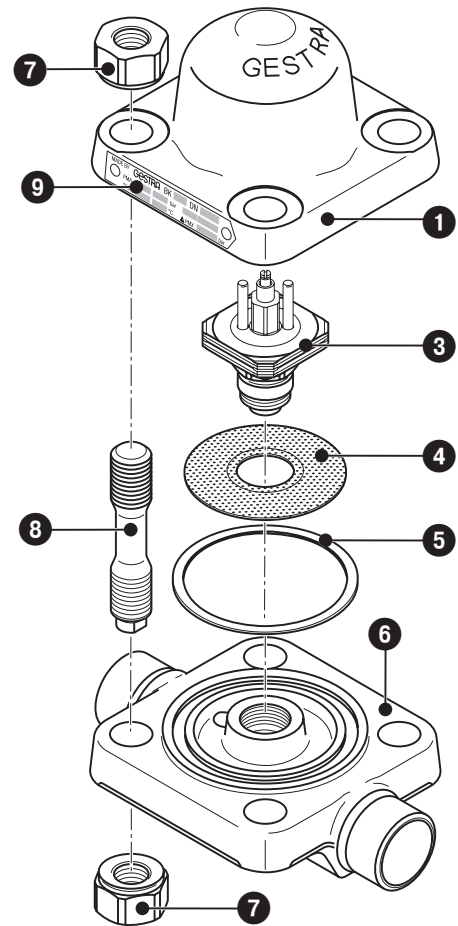

- 1 Cover
- 3 Thermovit® regulator BK 37, BK 37-ASME
- 4 Strainer
- 5 Gasket
- 6 Body
- 7 Hexagon nut DIN 2520
- 8 Stud bolt with reduced shank DIN 2520
- 9 Name plate

Spare parts list see page 4

Dimensions

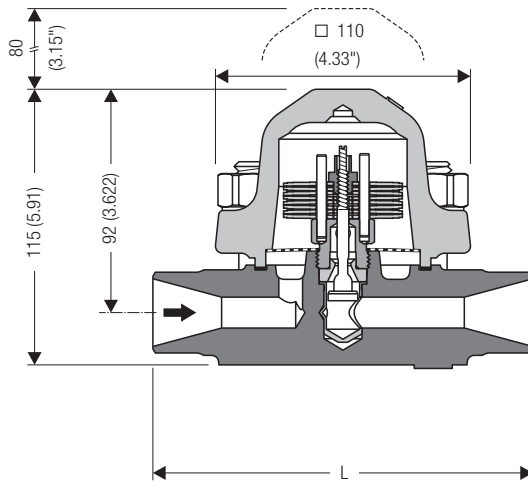

Weights and dimensions for traps with flanged ends

Type		EN 1092-1 PN 63			EN 1092-1 PN 100			DIN 2638 PN 160		
		15 mm	20 mm	25 mm	15 mm	20 mm	25 mm	15 mm	20 mm	25 mm
BK 37, BK 28, BK 29	DN	1/2	3/4	1"	1/2	3/4	1"	1/2	3/4	1"
	D [mm]	105	130	140	105	130	140	105		140
	L [mm]	210	230	230	210	230	230	210		230
	[kg]	8	9	10	8	9	10	8		10

D = Flange diameter

Type		ASME B 16.5 Class 400/600			ASME B 16.5 Class 600			ASME B 16.5 Class 900/1500		
		15 mm	20 mm	25 mm	15 mm	20 mm	25 mm	15 mm	20 mm	25 mm
BK 37, BK 28, BK 29	DN	1/2	3/4	1"	1/2	3/4	1"	1/2	3/4	1"
	D [mm]	95	115	125	95	115	125	120	130	150
	L [mm]	230	230	230	230	230	230	230	230	254
	[kg]	7	9	9	7	9	9	10	11	14

D = Flange diameter

Weights and dimensions for traps with butt-weld ends

Type		DIN 3239-1 DIN 2559-2			ASME B 16.25 ASME B 36.10		
		15 mm	20 mm	25 mm	15 mm	20 mm	25 mm
BK 37, BK 28, BK 29	DN	1/2	3/4	1"	1/2	3/4	1"
	for pipe	21.3 x 2.0	26.9 x 2.6	33.7 x 2.6	21.3 x 3.73	26.7 x 3.91	33.4 x 4.55
BK 37	L [mm]	160	160	160	160	160	160
BK 28	L [mm]	160	160	160	160	160	160
BK 29	L [mm]	160	160	160	200	200	200
BK 37, BK 28, BK 29	[kg]	5.0	5.0	5.0	5.1	5.1	5.1

Butt-weld ends for other pipe sizes available on request.

D = Flange diameter

Weights and dimensions for traps with socket-weld ends

Type		DIN EN 12760, ASME B 16.11		
BK 37, BK 28, BK 29	DN	15 mm	20 mm	25 mm
		1/2	3/4	1"
BK 37, BK 28, BK 29 Class 3000	L [mm]	160	160	160
BK 29 Class 6000	L [mm]	200	200	200
BK 37, BK 28, BK 29	[kg]	5.1	5.1	5.1

D = Flange diameter

Design BK 28-ASME, BK 29-ASME

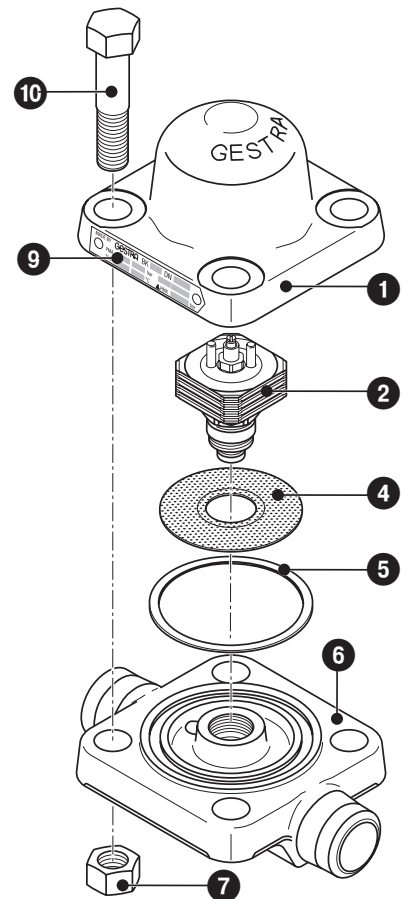

- 1 Cover
- 2 Thermovit® regulator
BK 28, BK 28-ASME, BK 29, BK 29-ASME
- 4 Strainer
- 5 Gasket
- 6 Body
- 7 Hexagon nut
- 9 Name plate
- 10 Threaded bolt

Spare parts list see page 4

Steam traps

BK 37 / BK 37-ASME

BK 28 / BK 28-ASME

BK 29 / BK 29-ASME

Capacity Chart

The chart shows the capacities for hot and cold condensate.

Curve ①

This curve indicates the max. capacity of hot condensate that the steam trap BK 37 can discharge with virtually no banking up.

Curve ②

This curve indicates the max. capacity of hot condensate that the steam traps BK 28 and BK 29 can discharge with virtually no banking up.

Curve ③

This curve indicates the max. capacity of cold condensate (20 °C) that the steam traps BK 37, BK 28 and BK 29 can discharge.

Capacity Chart

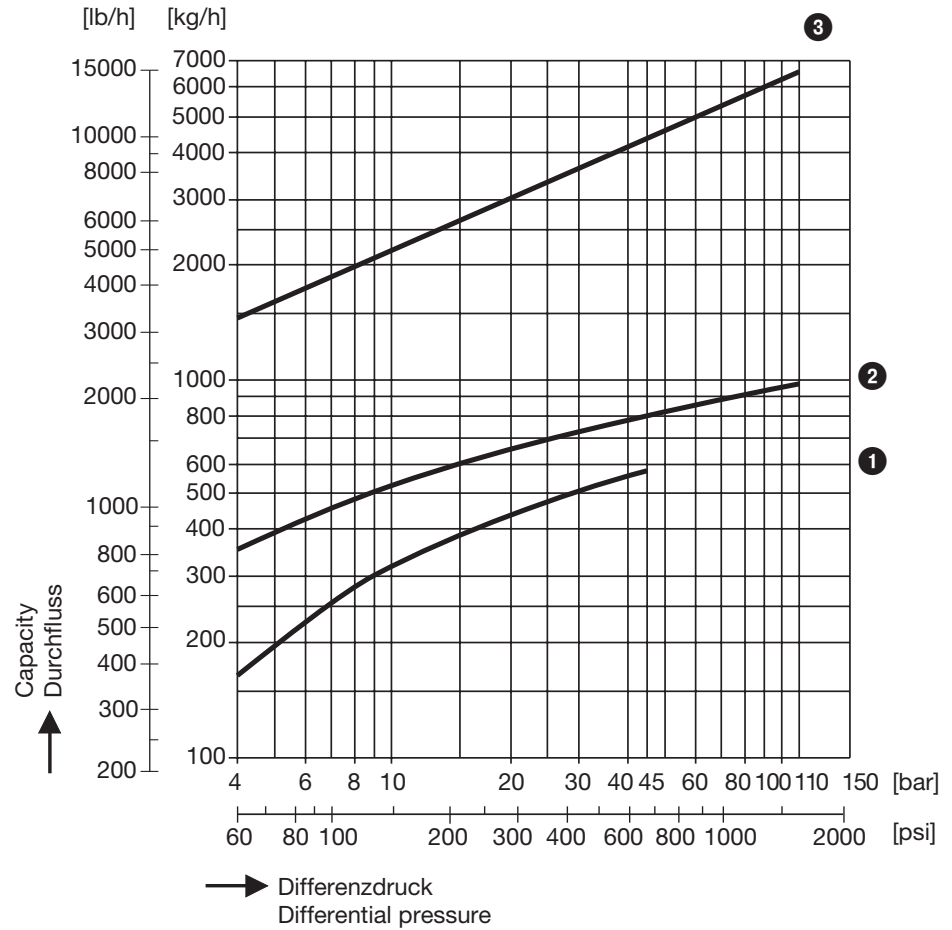

When ordering please state:

Material, material of screws/bolts, steam pressure & temperature, back pressure, condensate flowrate, design, end connections, nominal size, details of application or type of steam consumer.

The following test certificates can be issued on request, at extra cost:

In accordance with EN 10204-2.2, 3.1 and 3.2.

All inspection requirements have to be stated with the enquiry/order. After supply of the equipment certification cannot be established. Charges and extent of the above mentioned certificates as well as the different tests confirmed therein are listed in our price list "Test and Inspection Charges for Standard Equipment". For other tests and inspections please consult us.

PED (Pressure Equipment Directive)

The equipment fulfils the requirements of the Pressure Equipment Directive PED 97/23/EC.

For use with fluids of group 2.

The equipment is excluded from the scope of the PED according to Article 3.3 and must not bear a CE marking.

ATEX (Atmosphère Explosible)

The equipment does not have its own potential source of ignition and is therefore not subject to the ATEX Directive 94/9/EC.

Applicable in Ex zones 0, 1, 2, 20, 21, 22 (1999/92/EC). The equipment does not bear an Ex marking.

Supply in accordance with our general terms of business.

Spare Parts

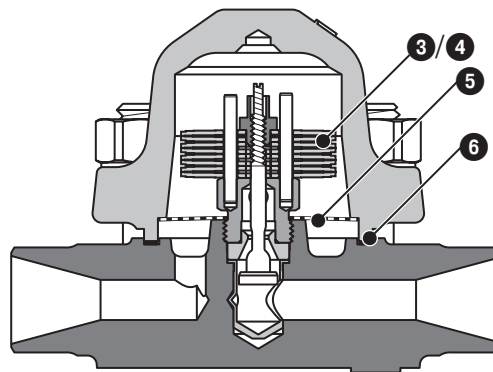

Item	Designation	Stock code
③, ⑥	Spare part kit for BK 28 and BK 28 ASME, cpl. with gasket	379825
	Spare part kit for BK 29 and BK 29 ASME, cpl. with gasket	379826
④, ⑥	Spare part kit for BK 37 and BK 37 ASME, cpl. with gasket	377722
⑤	Strainer	096701
⑥	Gasket for BK 28 and BK 28 ASME	086519
	Gasket for BK 37 and BK 37 ASME	
	Gasket for BK 29 and BK 29 ASME	372095

GESTRA AG

Münchener Straße 77, 28215 Bremen, Germany
 Telefon +49 421 3503-0, Telefax +49 421 3503-393
 E-mail info@de.gestra.com, Web www.gestra.de

