

# JAG

## PLATE HEAT EXCHANGERS



# JAG

## NEW PLATE HEAT EXCHANGER

Driven by a passion for innovation, Hexonic has provided effective heat transfer solutions for most applications. Working closely with our customers, our team of experienced engineers focuses on inventing new products and solutions in search of the most efficient ways of heat transfer. Our team of experienced engineers driven by passion for innovation gained knowledge across diverse market segments.

From that passion a new product has been born – JAG Plate Heat Exchanger with inventive jagged pattern of a heating plate.

Breaking new ground solution brings not only enhanced flow turbulence but also increased heat exchange area. Together it gives more compact, lighter but most of all more efficient device which can be customized to your individual requirements. Highly efficient JAG Plate Heat Exchanger will become a long-life dependable solution for your applications.

### APPLICATIONS



CHEMICAL  
INDUSTRY



FOOD & BEV  
INDUSTRY



HVAC-R



IRON AND STEEL  
INDUSTRY



PULP & PAPER  
INDUSTRY



MARINE  
INDUSTRY



POWER



PHARMACEUTICAL  
INDUSTRY





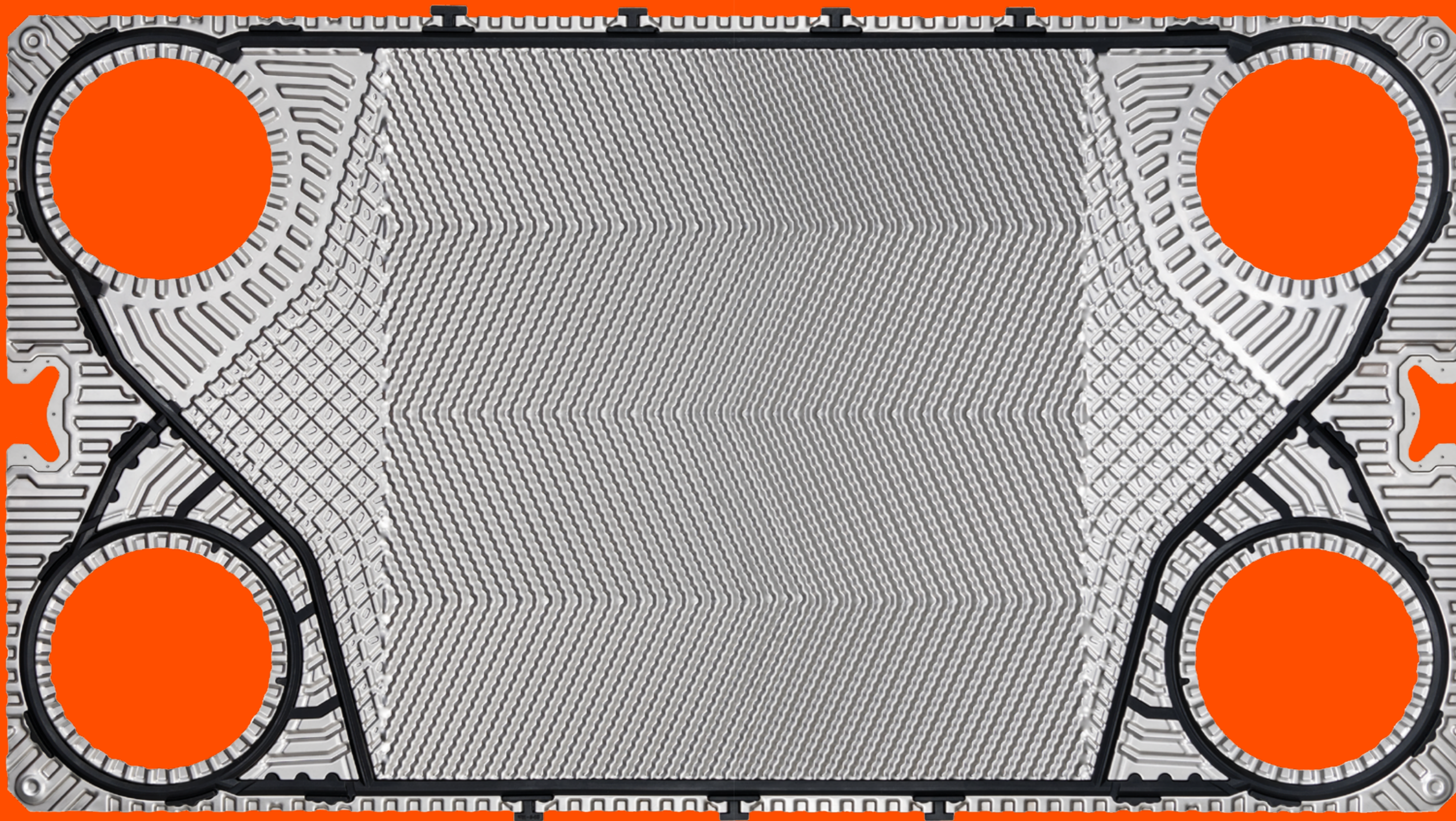



# INGENIOUS PATTERN

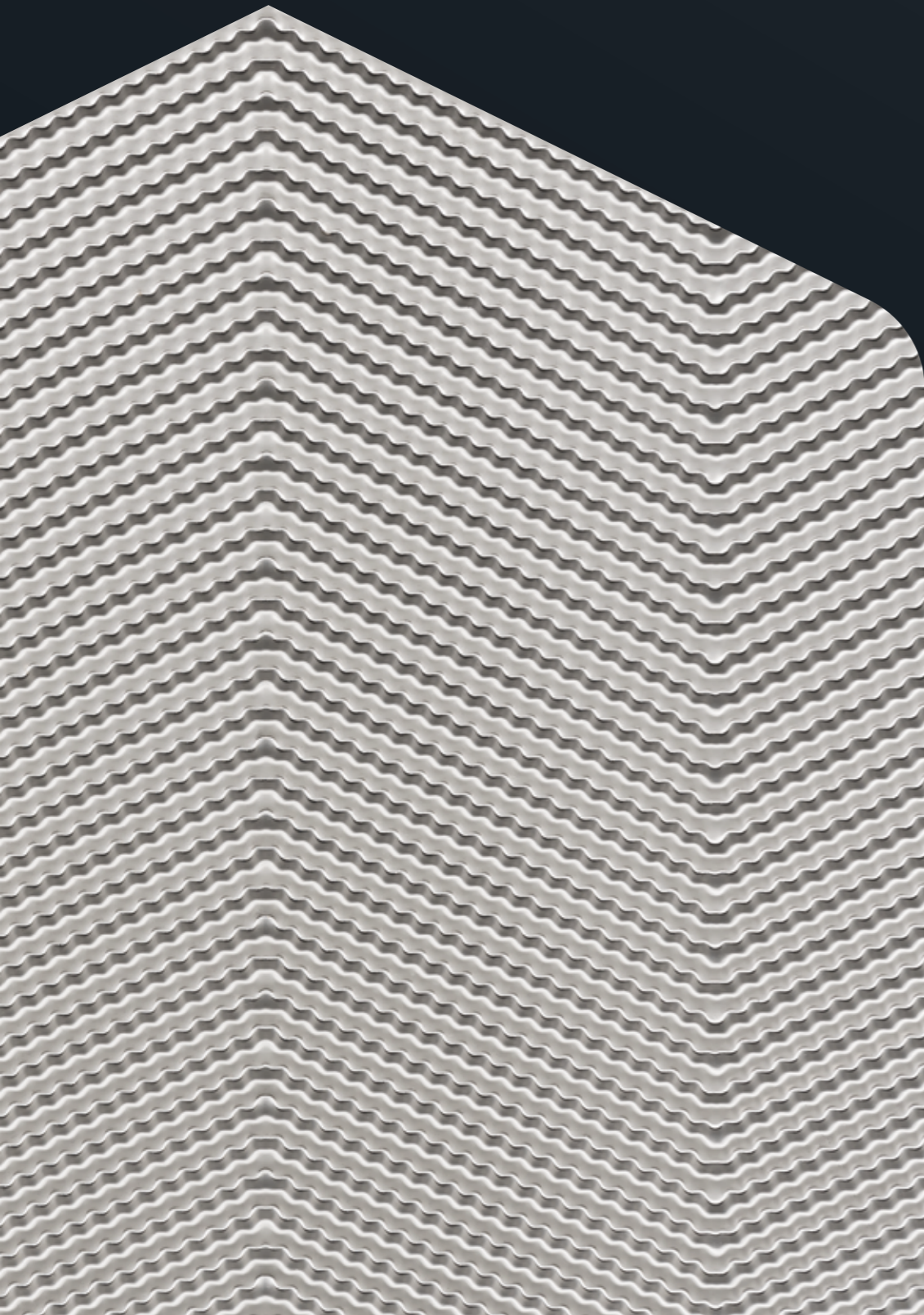

JAGGED  
/ˈdʒɑːɡɪd/  
WITH ROUGH, SHARP POINTS PROTRUDING

## THE INNOVATIVE JAG DESIGN IS THE RESULT OF OVER SIX YEARS OF RESEARCH AND DEVELOPMENT.

In search of optimal strength and thermal characteristics of the JAG geometry, a series of computational fluid dynamic analyses were performed. Together with other calculations and tests of prototypes they allowed to determine the precise channel performance in a plate heat exchanger.

Final tests confirmed that designed by Hexonic innovative corrugation JAG pattern combined with specially modelled plate geometry delivers up to 10% higher efficiency than the standard one. It is designed to substantially increase heat exchange as the "jagged" channels boost flow turbulence which enhances heat transfer, and reduces fouling. Furthermore, the design brings a bigger exchange area and general pressure drop levels are reduced.

Ingenious JAG technology brings you cutting-edge solutions within one plate.



INNOVATIVE  
CORRUGATION  
DESIGN



UP TO 10% HIGHER  
HEAT TRANSFER  
EFFICIENCY



ENHANCED FLOW  
TURBULENCE



UP TO 10% LOWER  
PRESSURE DROP FOR  
HIGH FLOW PATTERN



DECREASED  
FOULING



INCREASED HEAT  
EXCHANGE AREA



INCREASED PLATE  
DURABILITY



# JAG PLATE

## REINVENTED

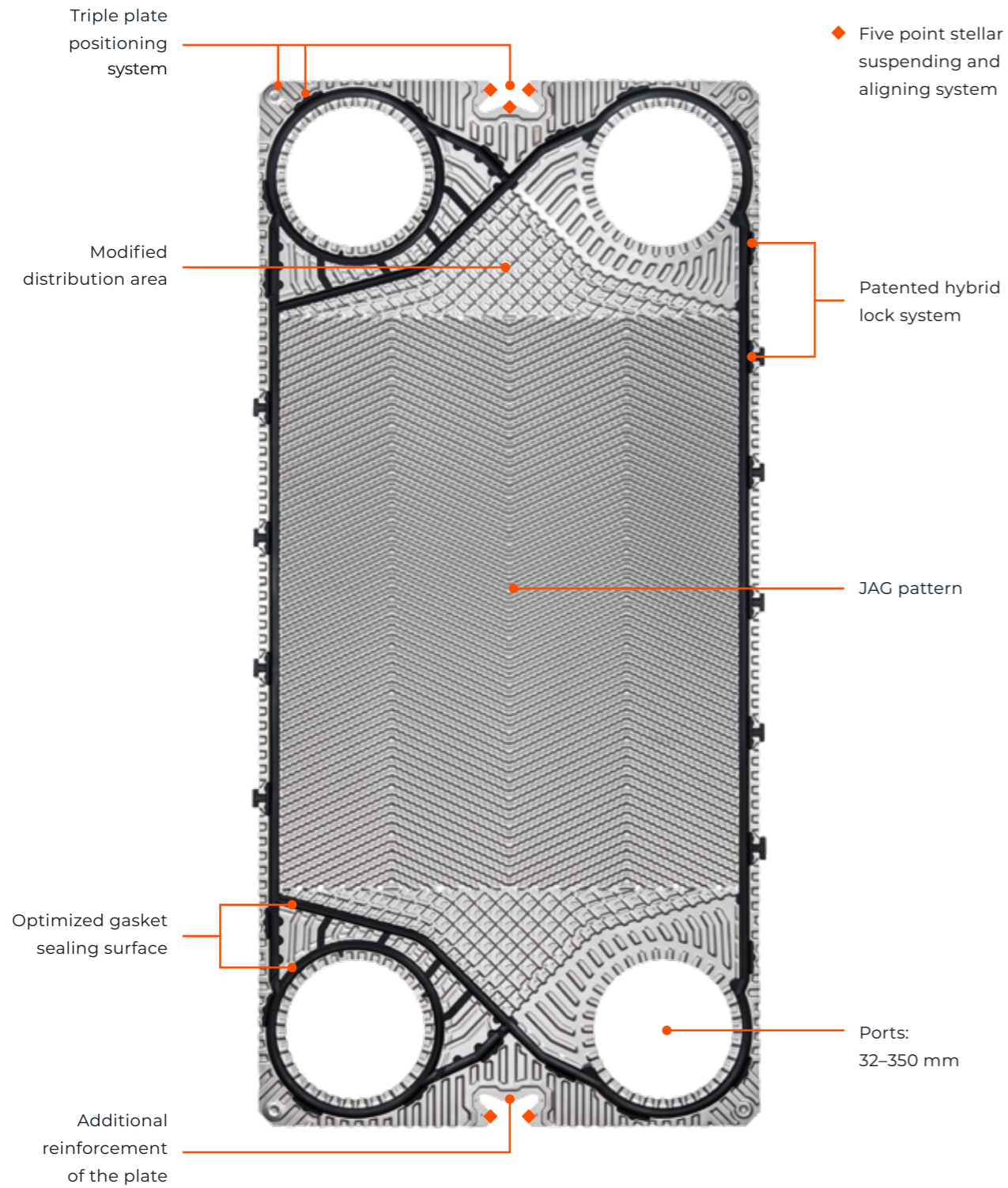

## SPECIAL PLATE FEATURES

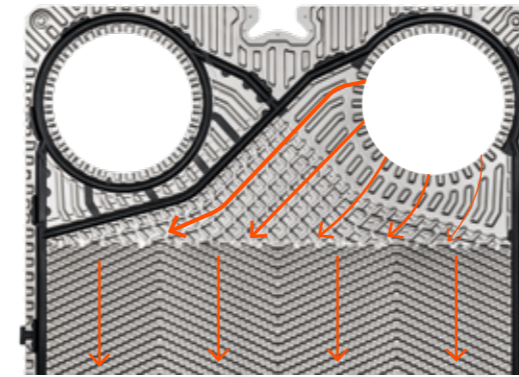

### MODIFIED DISTRIBUTION AREA

Additionally corrugated distribution area is designed to enhance turbulent flow in the entrance part of the plate. It also allows even flow through the plate which increases heat transfer by optimal use of its surface area.

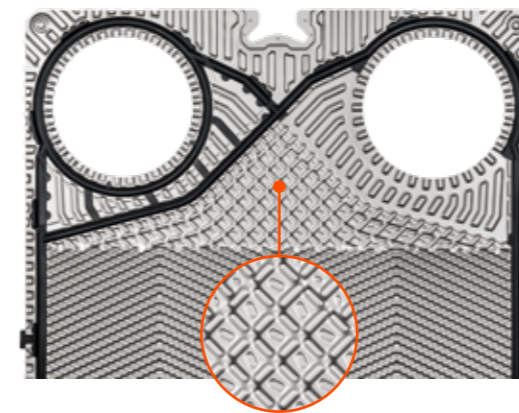

### PLATE REINFORCEMENT

Specifically corrugated distribution area strengthens the plate and increases the stability of the whole construction.

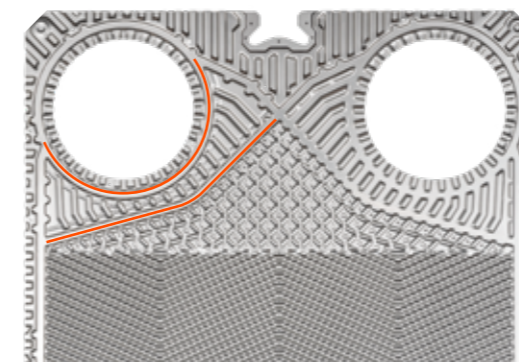

### OPTIMIZED GASKET SEALING SURFACE

Carefully designed groove together with specially modelled gasket makes the exchanger withstand high pressure.



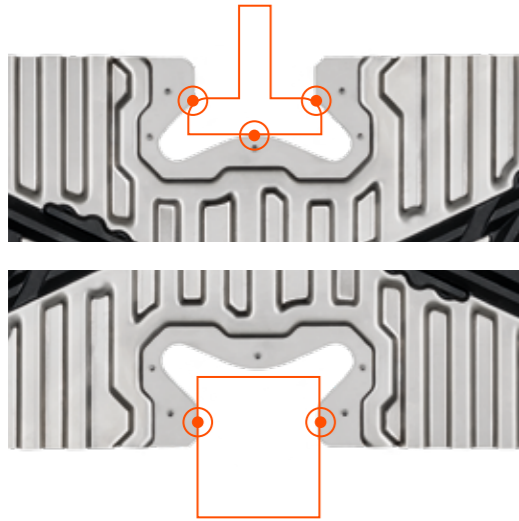

#### FIVE POINT STELLAR SUSPENDING AND ALIGNING SYSTEM

Five point suspending and aligning system ensures excellent alignment of the plates packet and guarantees correct sealing of the exchanger.



#### TRIPLE PLATE POSITIONING SYSTEM

Thanks to the three independent aligning systems the plates perfectly fit and therefore are secured from shaking or leaking. The system features:

- **GASKET ALIGNING SYSTEM**  
special protruding elements align the plates in relation to one another
- **POINT LOCKING SYSTEM**  
dedicated corrugated elements on the plate
- **STELLAR SUSPENDING SYSTEM**  
alignment in position to the upper and lower bar.

## THE FINITE ELEMENT METHOD ANALYSIS

The **Finite Element Method Analysis (FEM)** optimized the design of the JAG plate heat exchanger in terms of strength, mainly by improving the stress distribution on the cover plates and modifying the location of the fasteners, which contributed to the extension of the operating parameters.

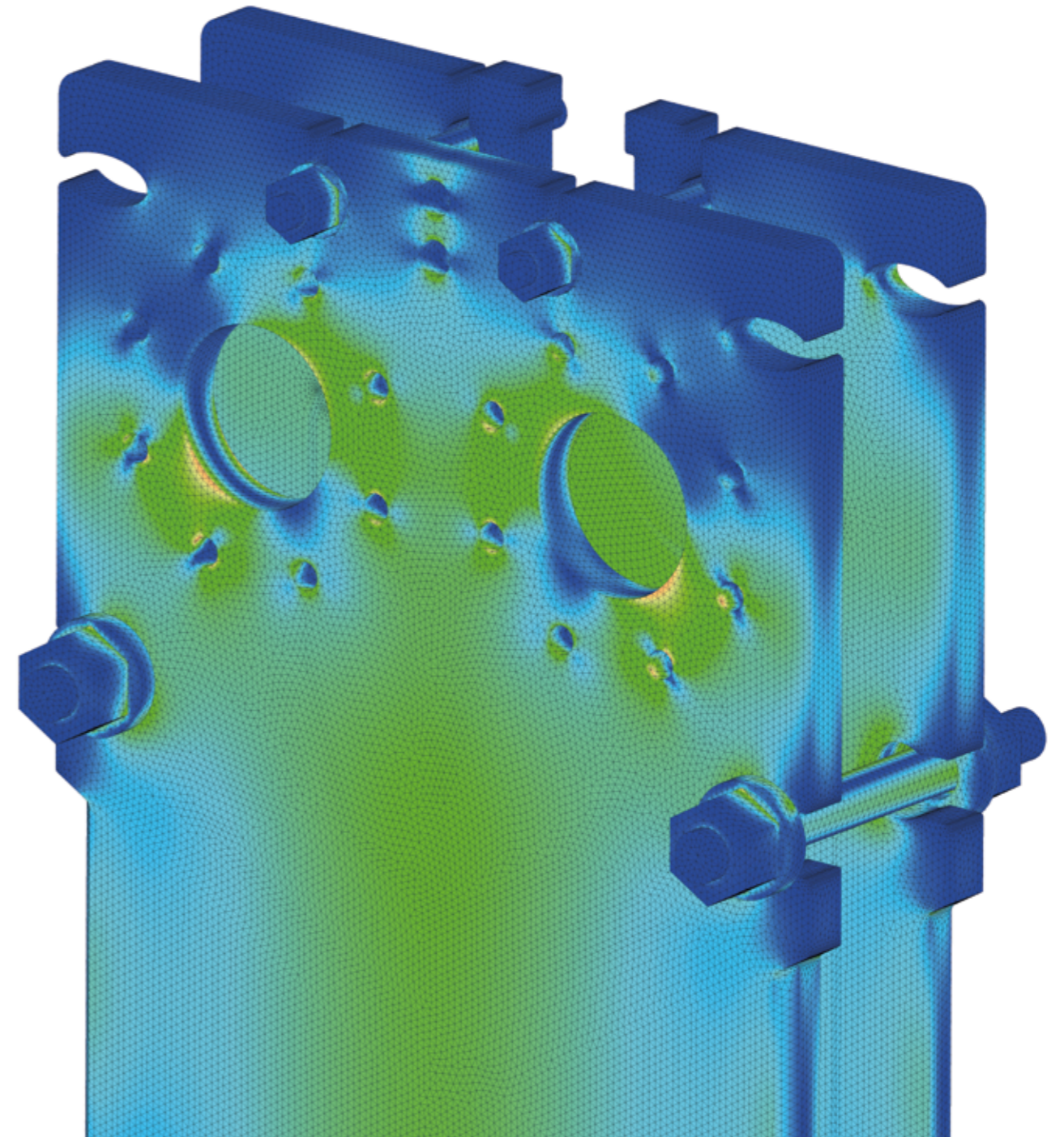







# GASKETS

## PATENTED HYBRID LOCK SYSTEM



New construction of the patented gasket features two locking methods and an optimized unique shape. The hybrid lock system makes the mounting easier, quicker, and more stable throughout the exchanger assembly process. The innovative shape provides superior sealing capacity even in high pressure applications.



### LOCK-IN METHOD

Each pin is pressed into the corresponding cut-out in the heating plate. Press-in locks stabilize the gasket on the plate during assembly.



### LOCK-ON METHOD

Each T-shape clip catches on the corresponding fragment of the profiled edge of the heating plate fastening the gasket to the vertical side of the plate. It makes the assembly process easier and quicker.

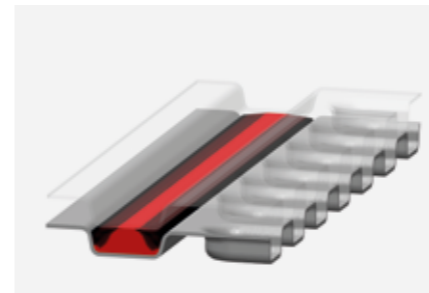

### OPTIMIZED UNIQUE SHAPE OF THE GASKET

Provides superior sealing capacity even in high pressure applications.

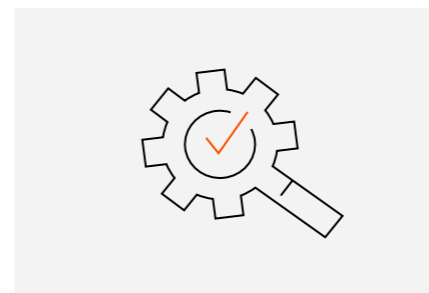

### HIGHEST PRODUCTION STANDARDS

Top quality materials and dependability of supply.



## CONSTRUCTION

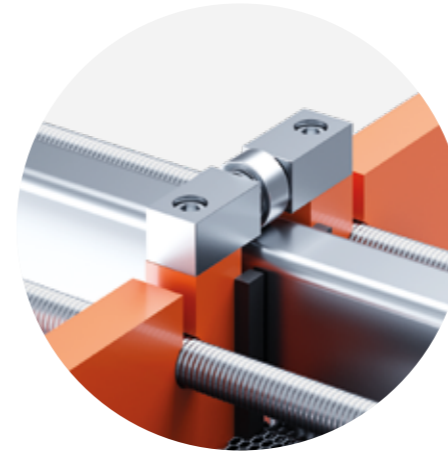

1

### METAL ROLLER

In larger models – enables easy sliding of the rear plate thus reducing maintenance time and effort. Rollers are accompanied by Teflon or polyamide slides to stabilize the rear plate.

2

Connection size: DN32 to DN350

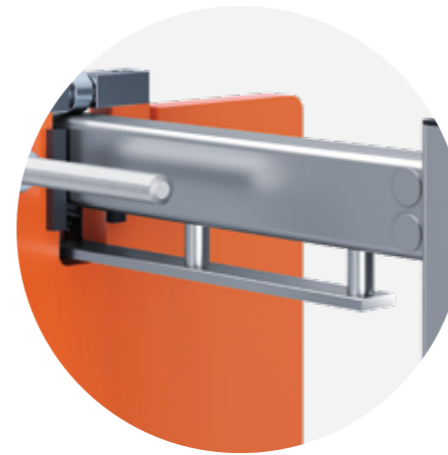

3

### SPECIAL PROFILE OF THE CARRYING BAR

Serves to suspend heating plates in larger models. It is part of the five-point alignment system that secures the heating plates in the correct position.

4

Front and rear plate available in various colours.

5

### ADDITIONAL FRONT FEET

Stabilize the heat exchanger and help to firmly attach it to the mounting platform.

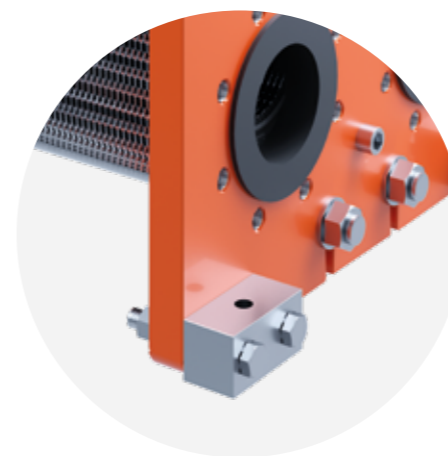



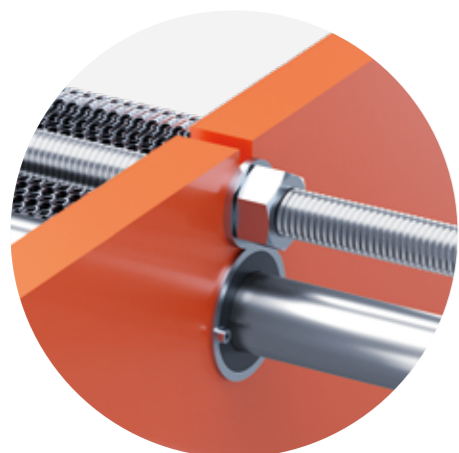

6

**SLIDING SLEEVE**

In smaller models – makes the service easier and reduces corrosion of the rear plate.

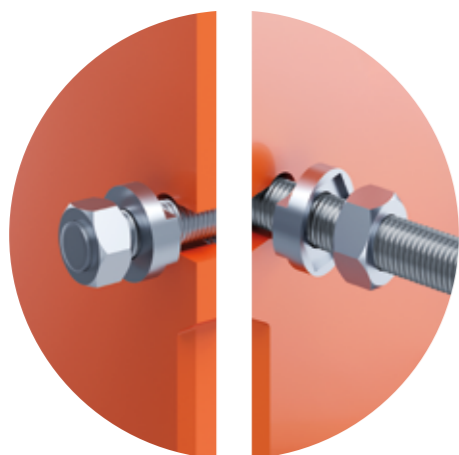

7

**LOCK WASHER**

Makes it easier and faster to loosen and tighten the bolts.

8

Other frame elements made of galvanized or stainless steel.

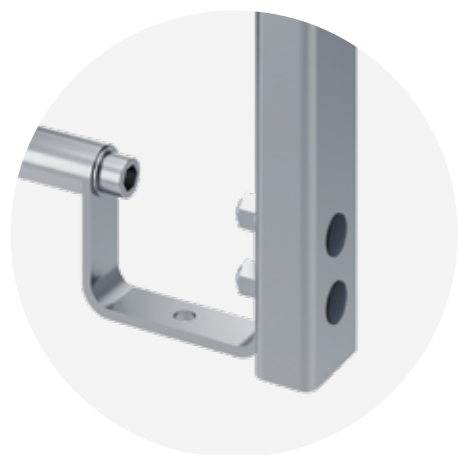

9

**U-LEG**

Enables easier assembly of the plate pack. It may also be used to fix the heat exchanger to the mounting platform.

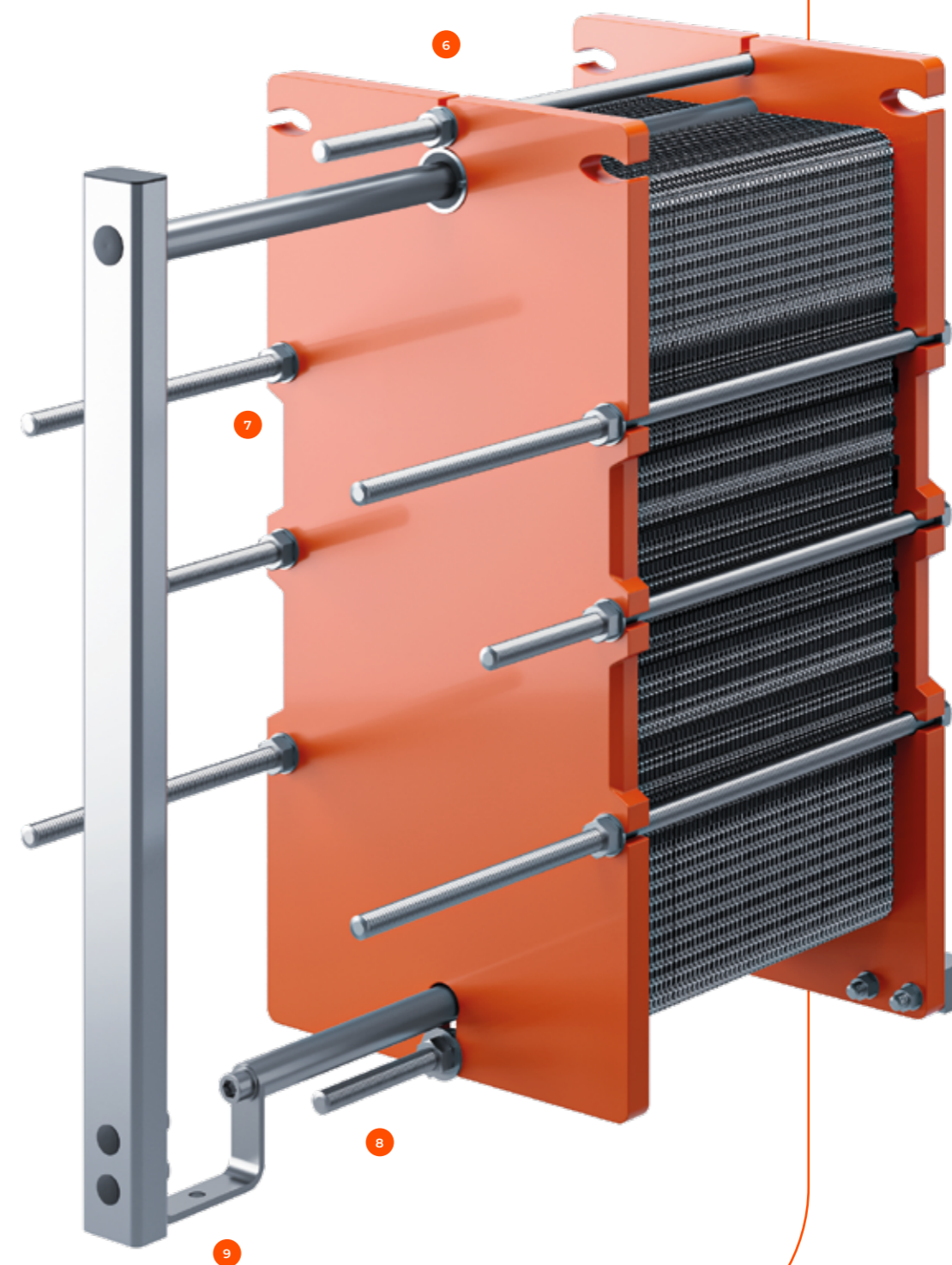



# POWER RUNS IN THE FAMILY

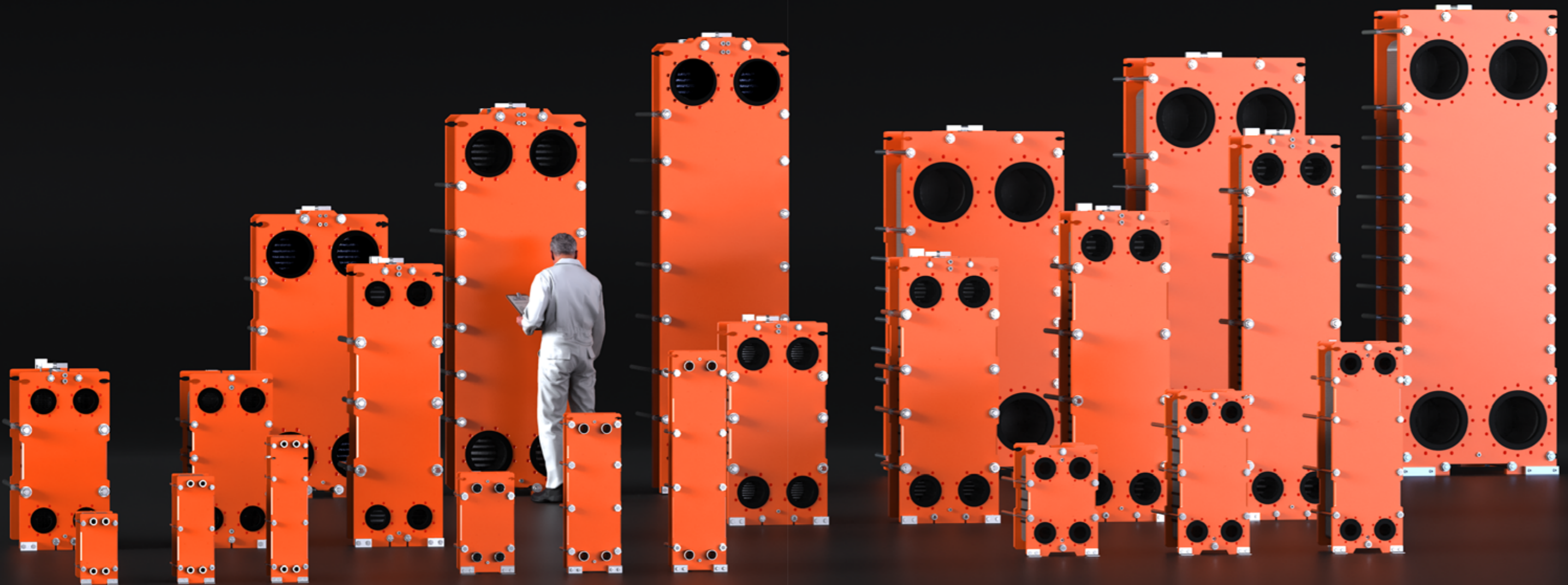



# TECHNICAL DATA

JAG	Max. heat transfer area of the exchanger	Connection size	Max. flow
	m <sup>2</sup>		m <sup>3</sup> /h
JFA-003	2,7	5/4"	15
JFA-006	5,4	5/4"	15
JFA-009	8,1	5/4"	15
JFB-010	15	2"	45
JFB-015	22,5	2"	45
JFB-025	37,5	2"	45
JFC-015	27	DN80	110
JFC-025	45	DN80	110
JFC-035	63	DN80	110
JFD-030	153	DN100	170
JFD-060	306	DN100	170
JFE-045	230	DN150	380
JFE-065	429	DN150	380
JFE-085	561	DN150	380
JFE-115	759	DN150	380
JFG-100	686	DN250	1 050
JFG-150	1 029	DN250	1 050
JFG-200	1 372	DN250	1 050
JFH-150	1 244	DN350	1 740
JFH-200	1 737	DN350	1 740
JFH-250	2 066	DN350	1 740

## ACCESSORIES



### DRIP TRAY

Its main function is to collect any condensates formed on the outside of the plates pack.



### INSULATION

Mineral wool covered with aluminium (AMWI) or polyurethane foam covered with aluminium (APFI).



### PROTECTION SHEET

Covers sides of the heating plates pack. Its role is to protect the surroundings of the exchanger from any sudden leak of hot or toxic media.



### CONNECTION BOLTS

Allow mounting the flange connection to the cover plate.

## HEATING PLATES MATERIAL

- STAINLESS STEEL 316L/1.4404, 304L/1.4307
- TITANIUM
- OTHER UPON REQUEST

## FRONT AND REAR PLATE

- CARBON STEEL
- VARIOUS COLOURS AVAILABLE UPON REQUEST
- STANDARD CORROSION CLASS C3
- CLASSES UP TO C5 POSSIBLE

## GASKET MATERIAL

- EPDM
- NBR
- FKM (VITON)

## SANITARY STANDARD

- FRONT AND REAR PLATES MADE OF STAINLESS STEEL 304L OR 316L, SPECIAL EASY-CLEANING HYGIENIC SHAPE
- HYGIENIC CONNECTIONS - DIN 11851
- SPECIAL FEET WITH SMALL FOOTPRINT

## TECHNICAL PARAMETERS

- MAX. PRESSURE 6, 10, 16, 25, 30 BAR
- MAX. TEMPERATURE 170 °C
- MIN. TEMPERATURE -20 °C

STANDARD - PED 2014/68/EU, OR ASME SEC VIII, DIV.1

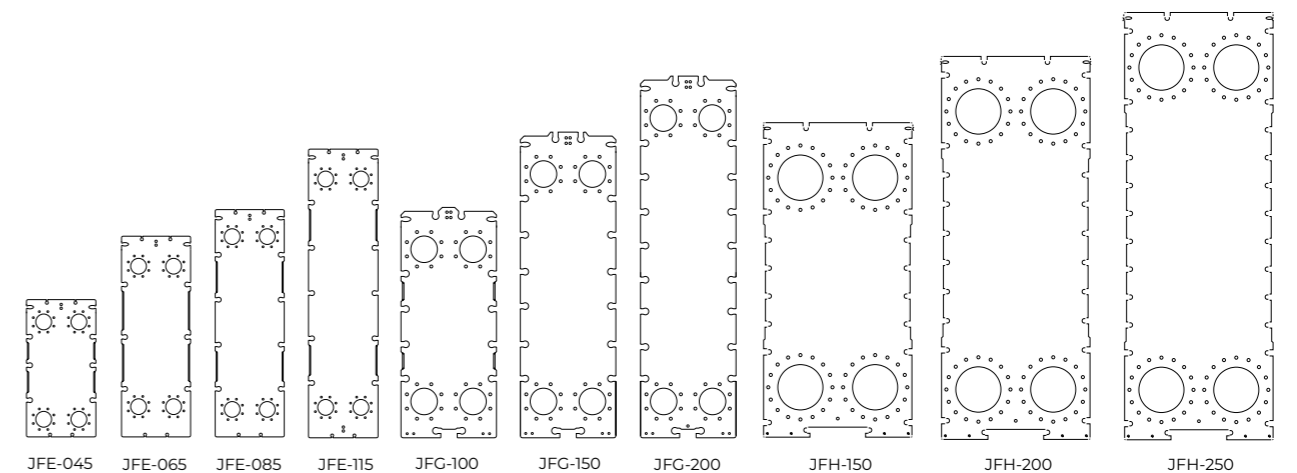
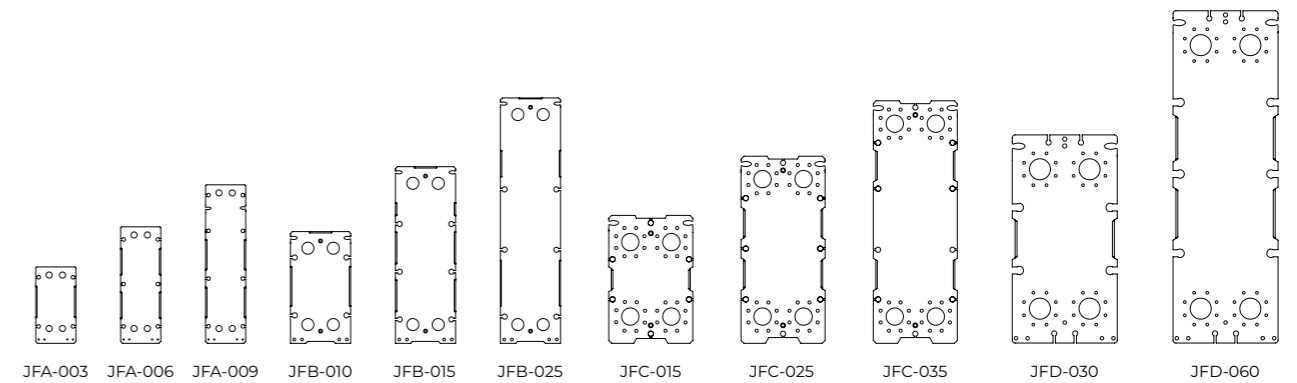



hexonic.com

**alnab**

EN.ver.1.2022

Alnab Armatur AB  
Ögärdesvägen 4B  
SE-433 30 Partille

Websida: [www.alnab.se](http://www.alnab.se)  
Tel: +46(0)31-449450

ver 1 2022